

FORMA DE SUMINISTRO

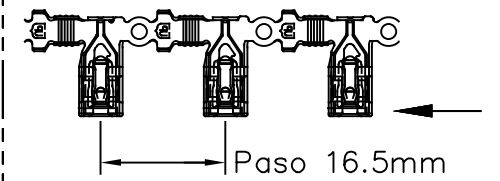

E 1/1

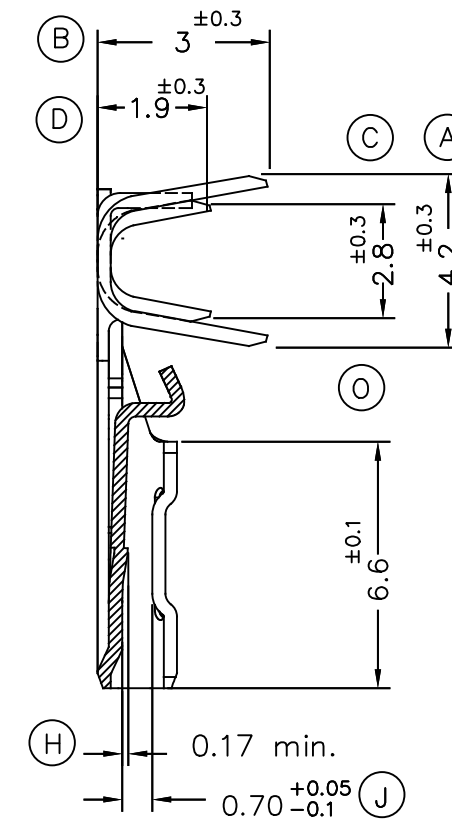
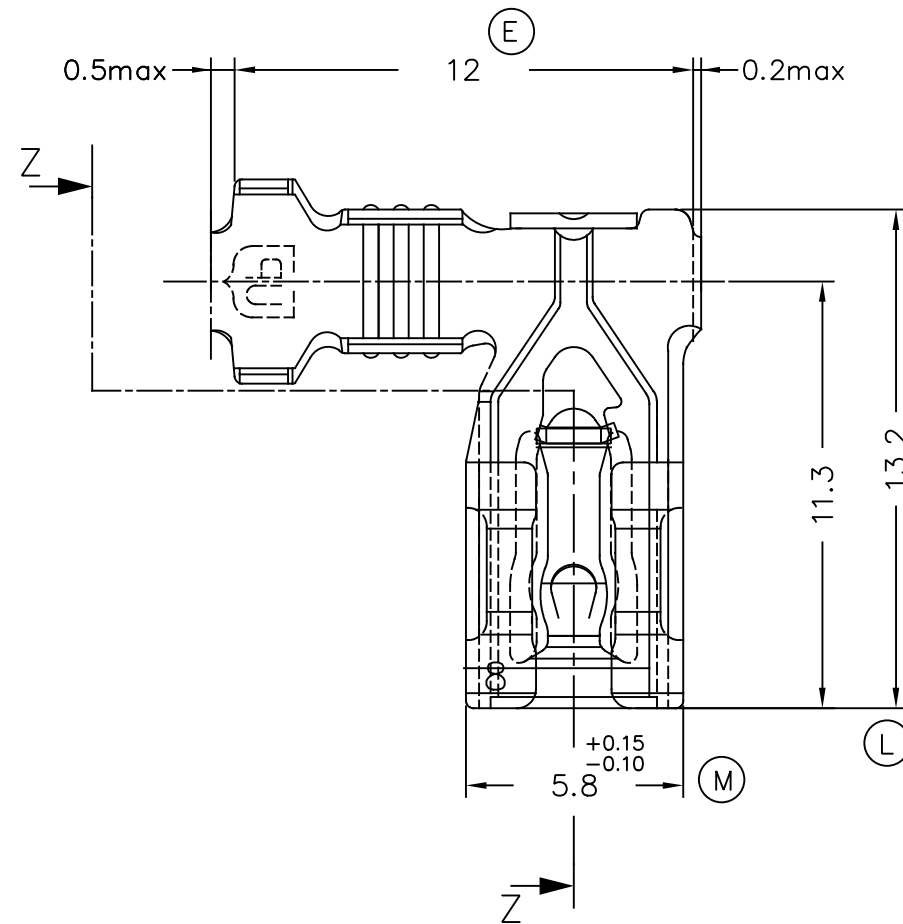
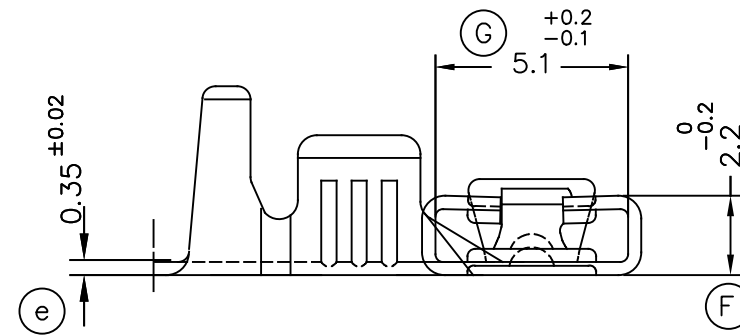

Secc.Z-Z

MACHO DE CONEXIÓN SUGERIDO/SUGGESTED MALE

- Material CuZn o Fe-Pre Ni
- Sin rebabas en el agujero/No burrs at hole
- Planitud dentro de 0.03mm en toda su longitud/Flatness within 0.03mm over the whole length
- Agujero simétrico sobre el eje del macho/ Hole be symmetrical about tab acc. drawing specification

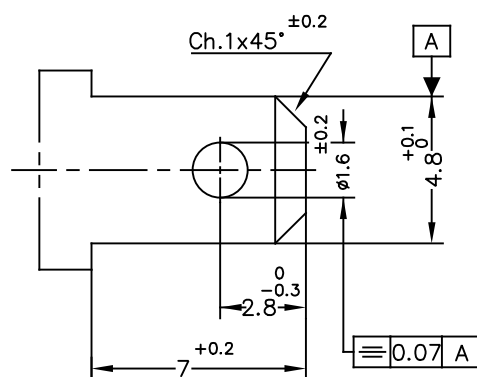
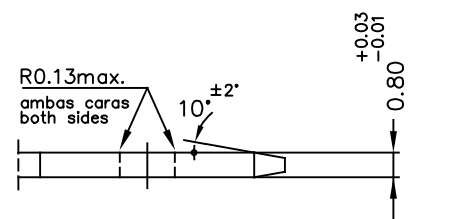

E 5:1

5773.51	Pre-Sn	CuNiSi*	0.2÷0.6mm ²	1.1÷2.1mm.	4.8x0.8	03	O.Roura	Modificación cota H	26/07/21
5773.24	Pre-Niq.	Acero				02	D.Yabar	Corregir cota macho PTC	12/06/20
5773.01	Pre-Sn	Latón*				01		Cotas palanca	28/08/19
5773.00	Natural	CuZn30				00		1ª Edición	12/07/16
Referencias	Acabados	Material	Sección Conductor	Ø Aislante	Para Macho	Rev.	Nombre	Modificación	Fecha



DIBUJADO VR 12/07/16

CONTROL XM 12/07/16

ESCALA 5/1

TERMINAL BANDERA HEMBRA Serie 4.8
UP-TPSEK3

NORMAS MATERIALES EN 1654 *
NORMAS DIMENSIONALES Especiales
TOLERANCIAS GENERALES ±0.2 ±2°



FORMATO A3h

NOMBRE PT5773 *c*

REF. 5773.xx