



5234.**

6.3 mm (.250) UP-TP Male-female terminals



Description Receptacles Minimum distance between male and female for tab 6.3 x 0.8

Wire section range 0.50 – 1.00 mm² (AWG 20 - 18)

Max. Insulator Ø 3.3 mm.

Materials, Temperature & Contact resistance

Part nr.	Material	Finishing	Max. temp. (C°)	Resist. (mΩ)
5230.00	Brass	Natural	110	(T.B.D)
5230.01	Brass	Pre-tin plated	120	0.52
5230.30	Bronze	Natural	120	1.17
5230.24	Steel	Nickel-plated	300	2.79

Notes: Temperatures as per IEC 61210 standard.
Maximal contact resistance: only contact zone

Material thickness 0.40 mm

Max. Rated current

Wire section (mm ²)	Current (A)
0.50	8
0.75	10
1.00	12

Note: Current carrying capacity according to wire size (IEC 60760)



Insertion/Withdrawal forces

1st. Insertion	35 N Max
1st. Withdrawal	30-60 N
6th. Withdrawal	22 N Min

Application tool MN5234

Wire stripping length 5.3 (±0.5) mm

Crimping parameters & Pull out force

Wire section (mm ² ±10%)		Conductor (±0.05)		Insulator (±0.15)	Pull-out force Min. (N)	
Nominal	Actual	Height (mm.)	Width (mm.)	Width (mm.)	DIN64249	ESCUBEDO
0.50	0.45	1.35	2.35	3.52	80	90
0.75	0.71	1.40	2.36	3.52	120	130
1.00	0.95	1.45	2.37	3.54	160	170

Note: Values only valid for the application tool specified upwards. The insulator widths are only indicative as they are dependent on the sheath thickness of the wire used.

Packaging 2750 Pieces on 30 mm. cardboard reel, 19.5 mm terminal chain pitch

Drawing

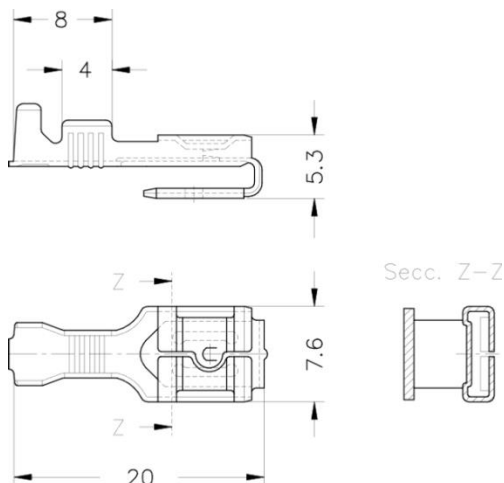

Approvals

- RoHS Compliant





5234.**

6.3 mm (.250) UP-TP Male-female terminals



Thermal derating curves

(Maximum current vs. maximum ambient temperature)
Note: 20% security margin is applied on all derating curves.

Thermal rise curves

Pre-tin plated bass

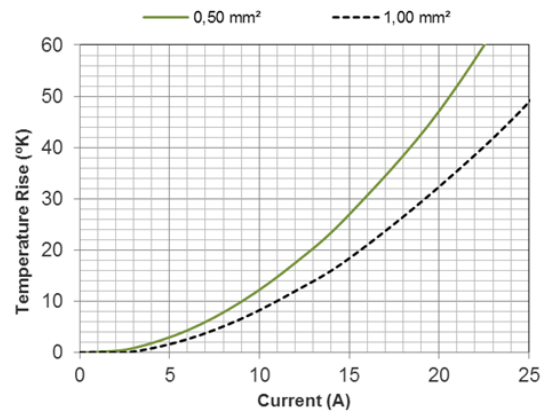
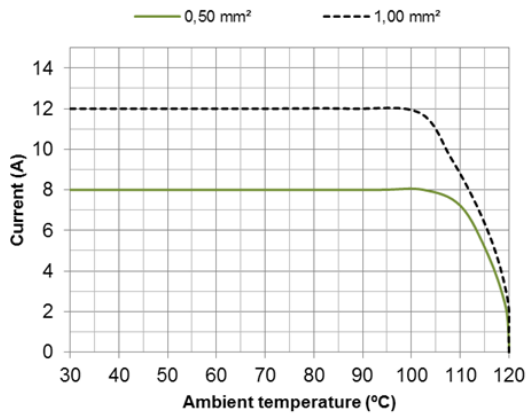

Natural bronze

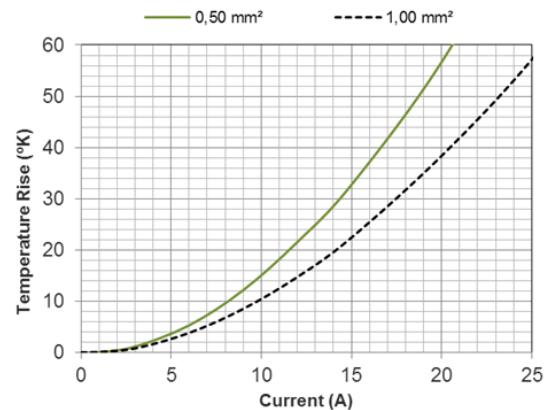
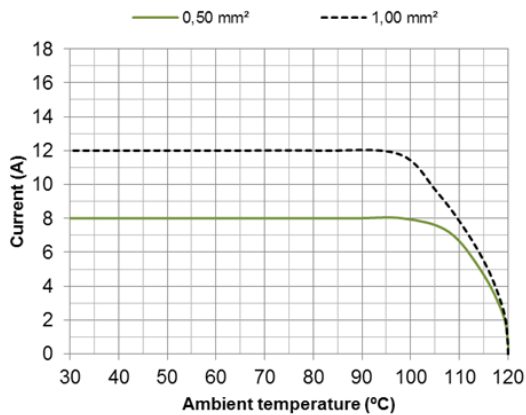

Nickel-plated steel

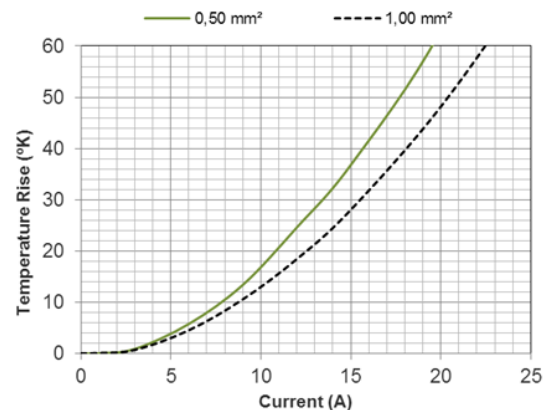
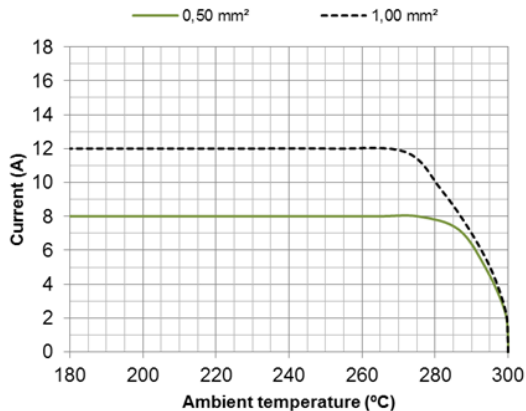

Disclaimer

Data obtained from Escubedo Laboratory essays, using own methodology, cablings, equipment and original crimping tools, done in laboratory conditions and following the indicated standards, errors and omissions excepted. This document has no contractual meaning and it is publicised only for informative purposes. It can be changed without prior notice. The end customer has the sole responsibility to check these characteristics in its environment and with its own components, manufacturing methods and equipment. See also the full range product overview if available. For further information please visit our web site or contact us.

Rev. Nr.	Modification	Date	Created/Revised	Approved
1	Creation/update	07/03/2014	D.Martinez	A.Calvet