

SECC. A-A'

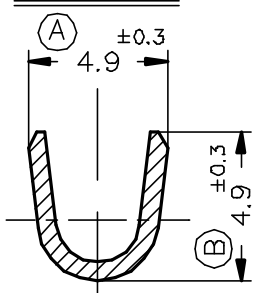

SECC. B-B'

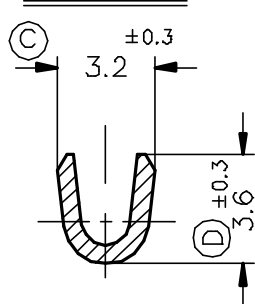

FORMA DE SUMINISTRO

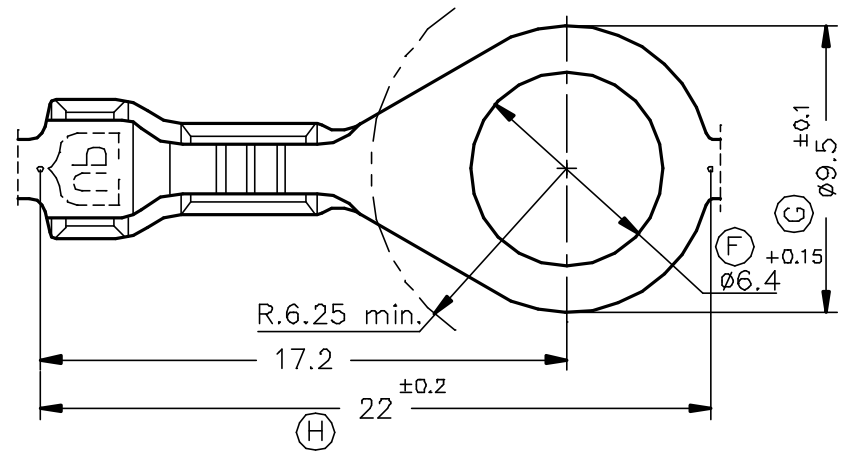
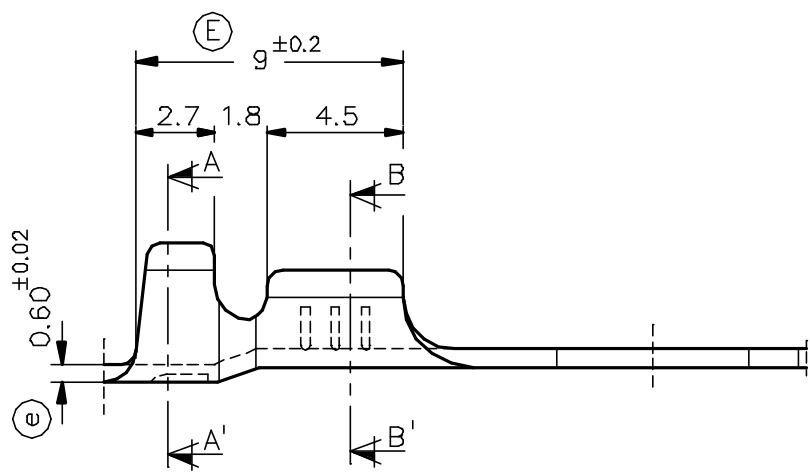
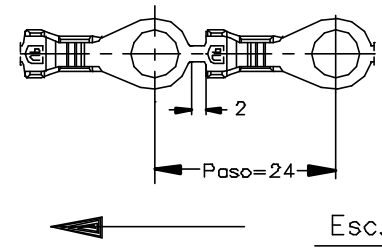

3404.32	Estañado	Bronce	0.5 ÷ 1mm ²	1.8 ÷ 2.5mm.								
3404.30	Natural	CuSn5										
3404.02	Estañado	Latón										
3404.00	Natural	CuZn30							00	1ª Edición	10/09/96	
Referencias	Acabados	Material	Sección Conductor	∅ Aislante	A	B	C	D	Rev.	Modificación	Fecha	



TERMINAL PARA TORNILLO Placa ∅9.5 A6-1



DIBUJADO	Gemma	10/09/96	NORMAS MATERIALES DIN17670	NORMAS DIMENSIONALES Especiales	TOLERANCIAS GENERALES ±0.2 ±2°	FORMATO	A4v
CONTROL	F.Adamuz	10/09/96				NOMBRE	PT3404 "c"
ESCALA	4/1		REF.		3404.xx		