

SECC. A-A'

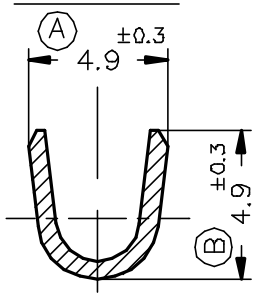

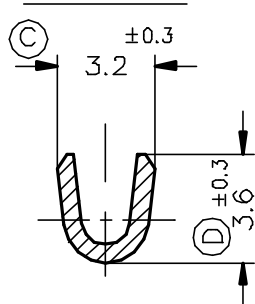

SECC. B-B'

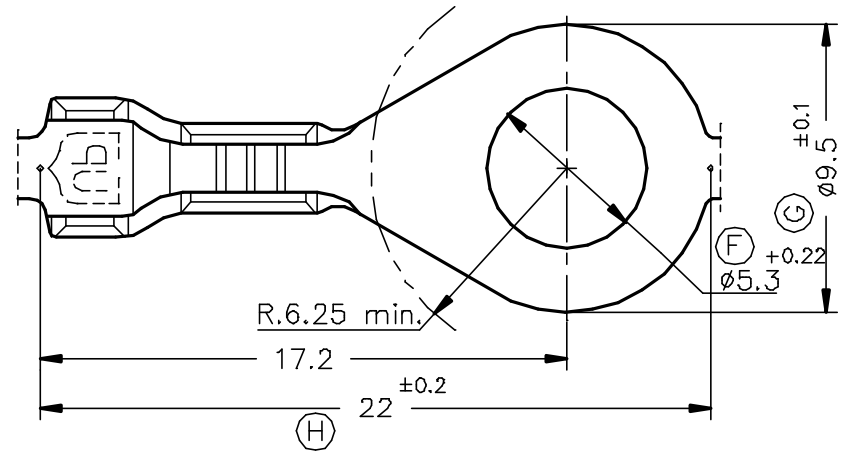
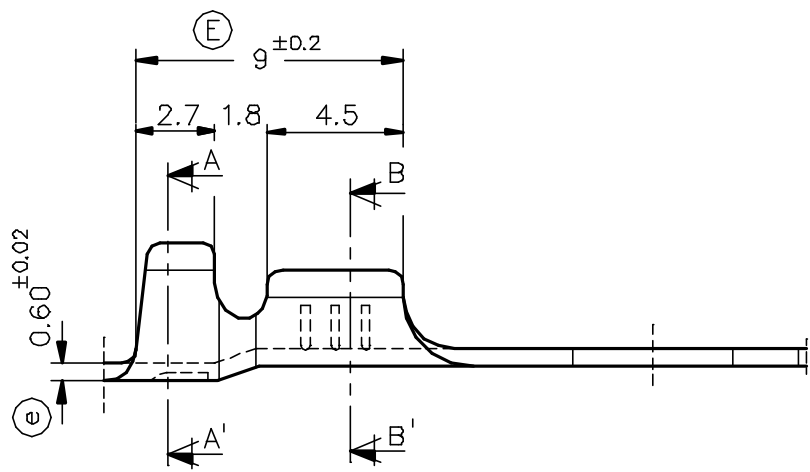
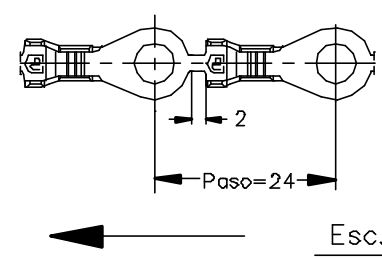

FORMA DE SUMINISTRO



|             |          |          |                        |              |   |   |   |   |      |                        |          |  |
|-------------|----------|----------|------------------------|--------------|---|---|---|---|------|------------------------|----------|--|
| 3403.32     | Estañado | Bronce   | 0.5 ÷ 1mm <sup>2</sup> | 1.8 ÷ 2.5mm. |   |   |   |   |      |                        |          |  |
| 3403.30     | Natural  | CuSn6    |                        |              |   |   |   |   |      |                        |          |  |
| 3403.02     | Estañado | Latón    |                        |              |   |   |   |   | 01   | Tol.cotaF(+0,15a+0,22) | 12/07/02 |  |
| 3403.00     | Natural  | CuZn30   |                        |              |   |   |   |   | 00   | 1ª Edición             | 10/09/96 |  |
| Referencias | Acabados | Material | Sección Conductor      | φ Aislante   | A | B | C | D | Rev. | Modificación           | Fecha    |  |

|  |          |   |   |  |  |  |  |  |  |  |
|--|----------|---|---|--|--|--|--|--|--|--|
|  <b>ESCUBEDO</b><br>Especialitats Elèctriques Escubedo S.A. |          |   | <b>TERMINAL PARA TORNILLO Placa ø9.5 A5-1</b> |  |  |  |  |  | <b>Terminales</b><br> |  |
| DIBUJADO   | Gemma    | 10/09/96  |   |  |  |  |  |  | NORMAS MATERIALES<br>EN 1652   |  |
| CONTROL  | F.Adamuz | 10/09/96  |   |  |  |  |  |  | NOMBRE<br>PT3403 "c"   |  |
| ESCALA   | 4/1      |  |   |  |  |  |  |  | REF. 3403.xx   |  |