

5817.**

4.8 MM (.187) UP-TP FLAG TERMINALS





Description Flag receptacles Low insertion for tab 4.8*0.5

Wire section range 0.30 – 0.75 mm² (AWG 22 - 18)

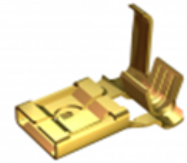
Max. Insulator Ø 2.1 mm.



Materials, Temperature & Contact resistance

Part nr.	Material	Finishing	Max. temp. (C°)	Resist. (mΩ)	UL regulation
5817.00	Brass	Natural	110	0.85	
5817.01	Brass	Pre-tin plated	120	0.75	
5817.24	Steel	Nickel-plated	300	1.85	

Material thickness 0.35 mm

Max. Rated current

Wire section (mm ²)	Current (A)
0.30	(T.B.D.)
0.50	8
0.75	10

Insertion/Withdrawal forces

1st. Insertion	25 N Max.
1st. Withdrawal	22-50 N
6th. Withdrawal	13 N Min.

Application tool MN5819

Wire striping length 2.70(±0.5) mm

Crimping parameters & Pull out force

Wire section (mm ² ±10%)		Conductor (mm) 		Insulator (mm)	Pull-out force (N)
Nominal	Actual	Height (±0,05)	Width (measured)	Width (measured)	Escubedo
0.30	0.31	1.20	1.87	3.15	>50
0.50	0.45	1.25	1.88	3.15	>85
0.75	0.71	1.30	1.89	3.15	>125

Note: Values only valid for the application tool specified. The insulator width is only indicative as they depend of the insulation properties.

Packaging 5000 Pieces on 16 mm. cardboard reel, 15.5 mm terminal chain pitch

5817.**

4.8 MM (.187) UP-TP FLAG TERMINALS



Drawing

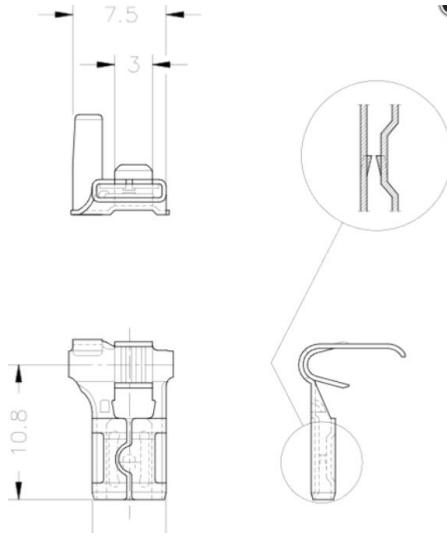

Approvals

- RoHS Compliant



- UL (see table above)



Connectors Compatibility

Part Number	Nº of Ways	Color	PA NF	PA66 V2	PA66 V0
2483310	1	Natural	-	x	-
2483330	1	Natural	-	-	x
2483340	1	Natural	x	-	-

Note: For others materials and colours consult the specific datasheet

5817.00 NATURAL BRASS
4.8 MM (.187) UP-TP FLAG TERMINALS



Derating Curve. Current carrying capacity vs. Ambient Temperature

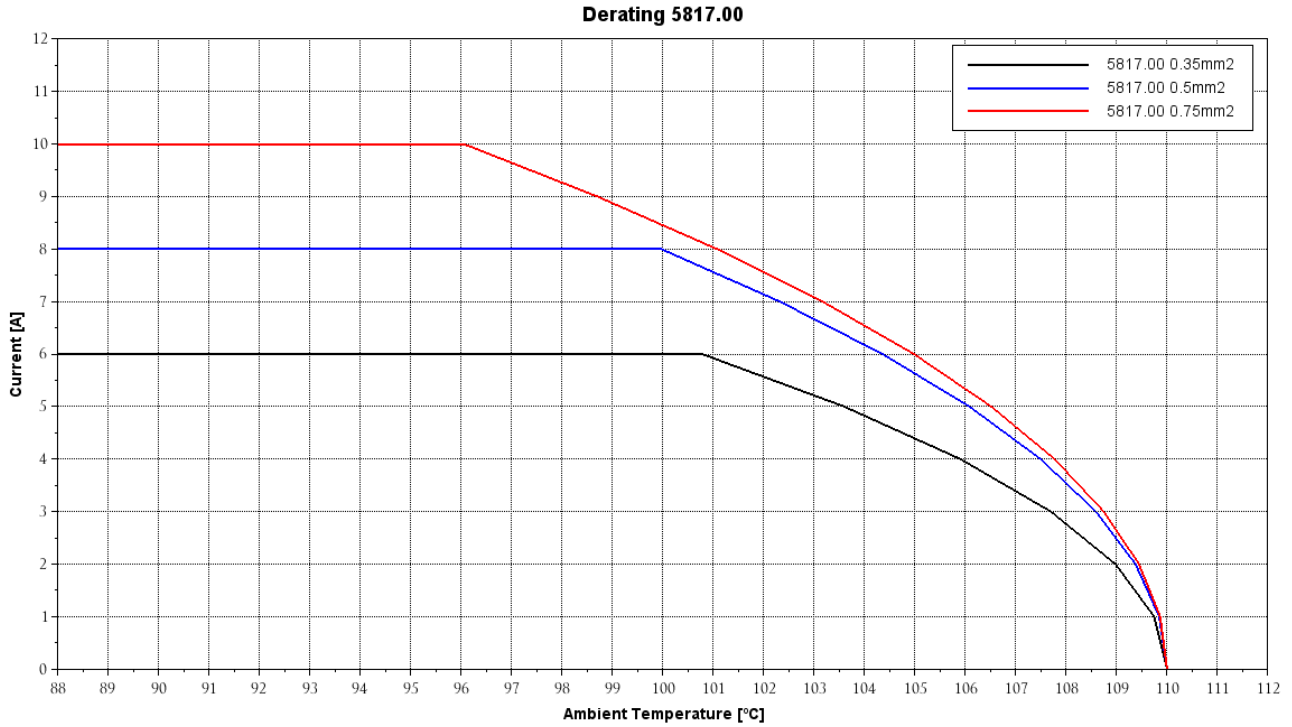

Temperature Rise Curve. Terminal Temperature rise due to the current carried

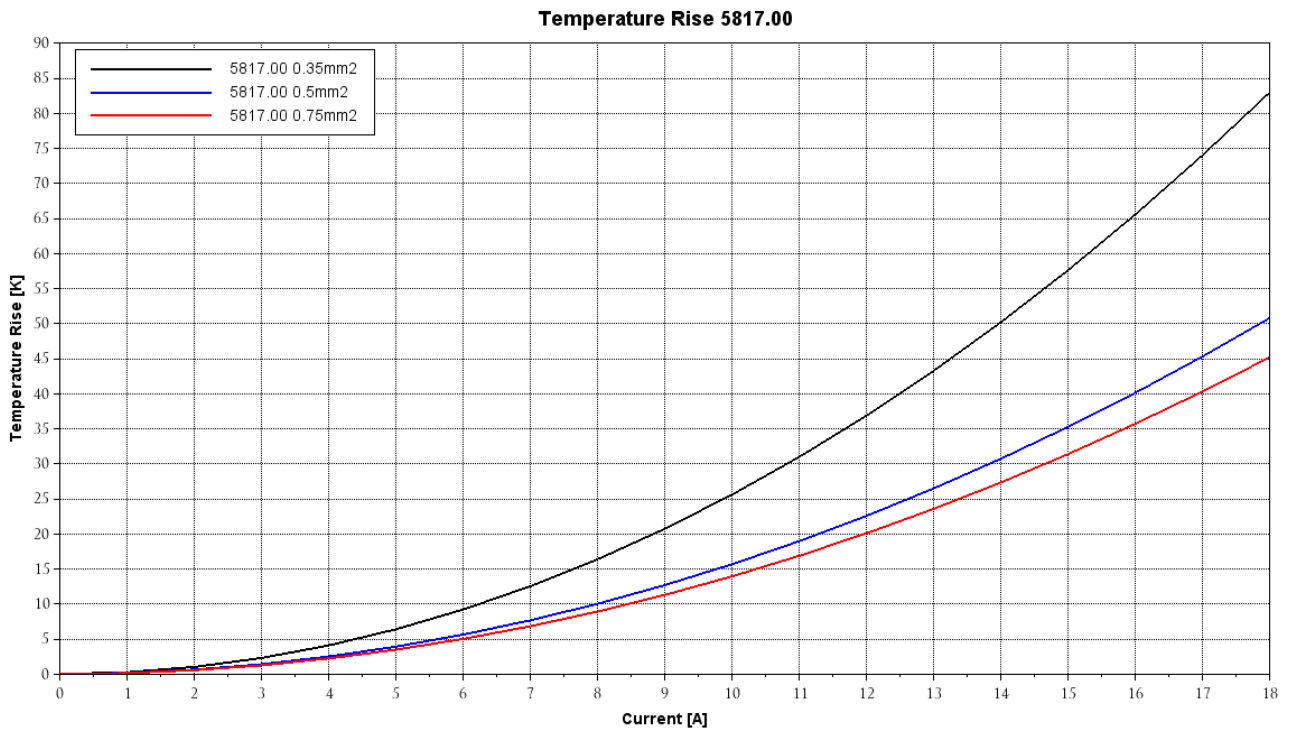

Curves show terminal behavior in a first connection, working in open air (without connector). Security margin has been applied.

5817.01 PRE-TIN PLATED BRASS
4.8 MM (.187) UP-TP FLAG TERMINALS



Derating Curve. Current carrying capacity vs. Ambient Temperature

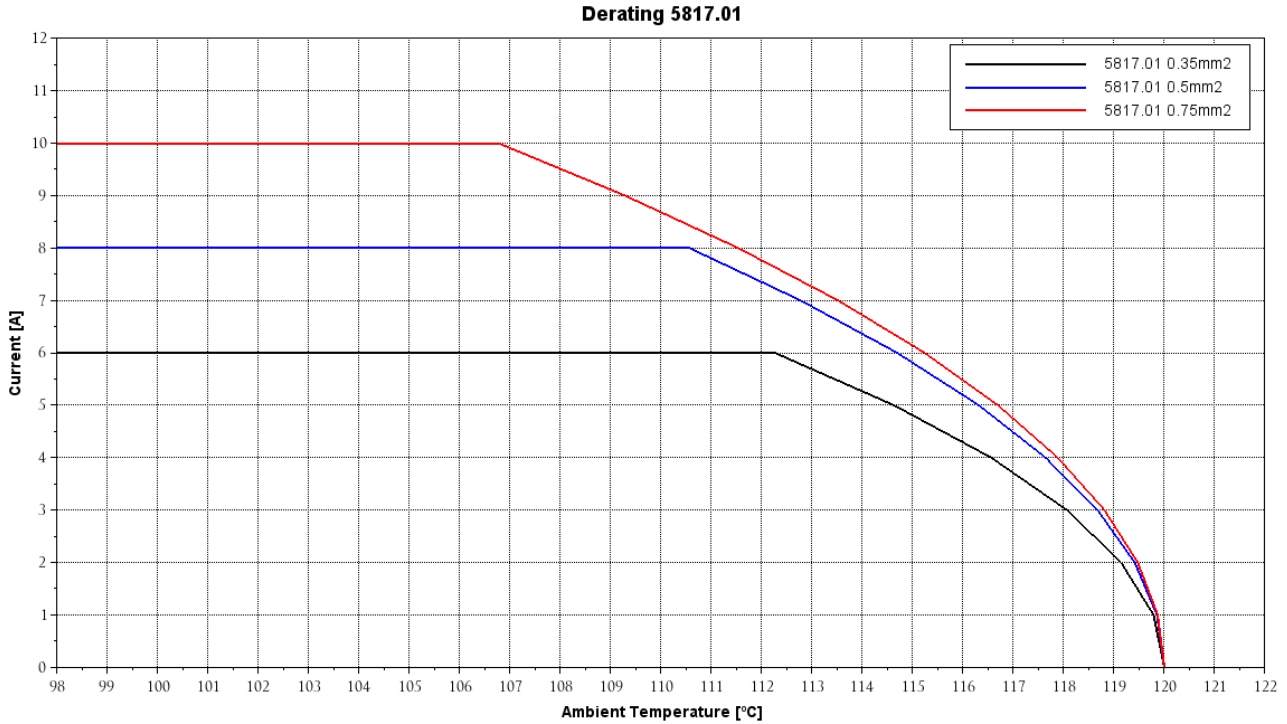

Temperature Rise Curve. Terminal Temperature rise due to the current carried

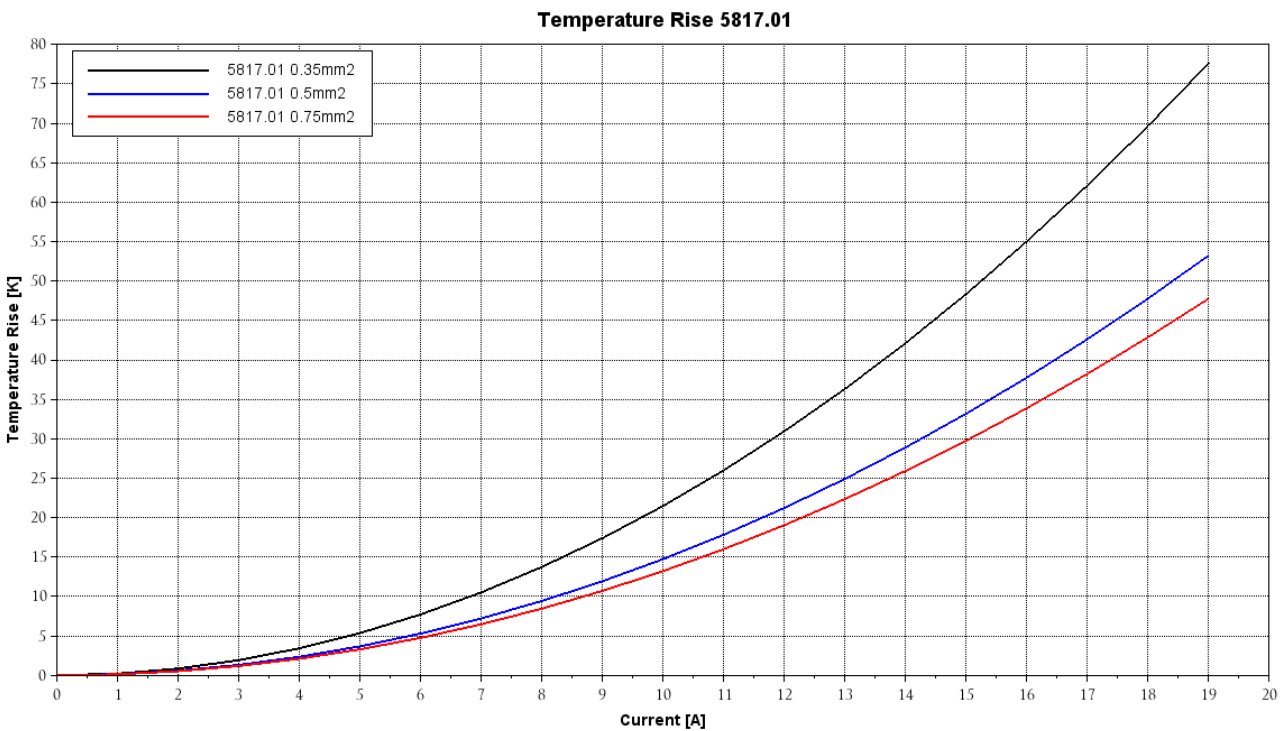

Curves show terminal behavior in a first connection, working in open air (without connector). Security margin has been applied.

5817.24 NICKEL PLATED STEEL
4.8 MM (.187) UP-TP FLAG TERMINALS



Derating Curve. Current carrying capacity vs. Ambient Temperature

Derating 5817.24

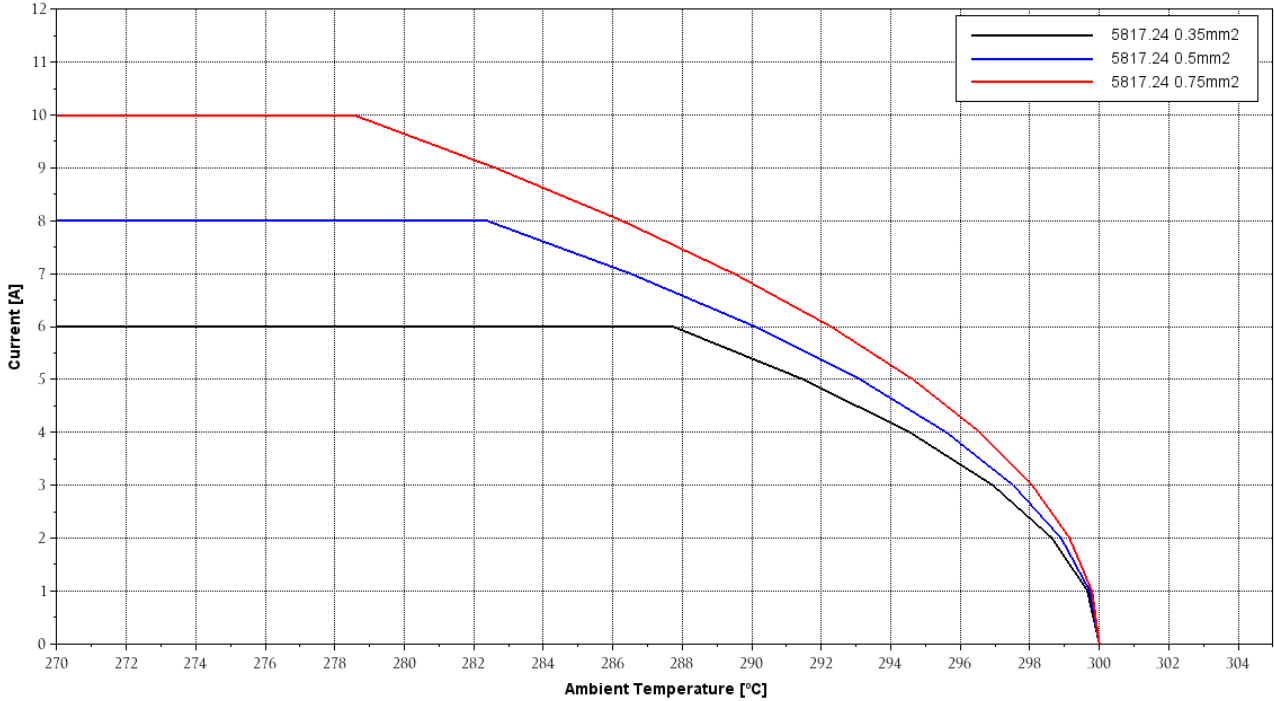

Temperature Rise Curve. Terminal Temperature rise due to the current carried

Temperature Rise 5817.24

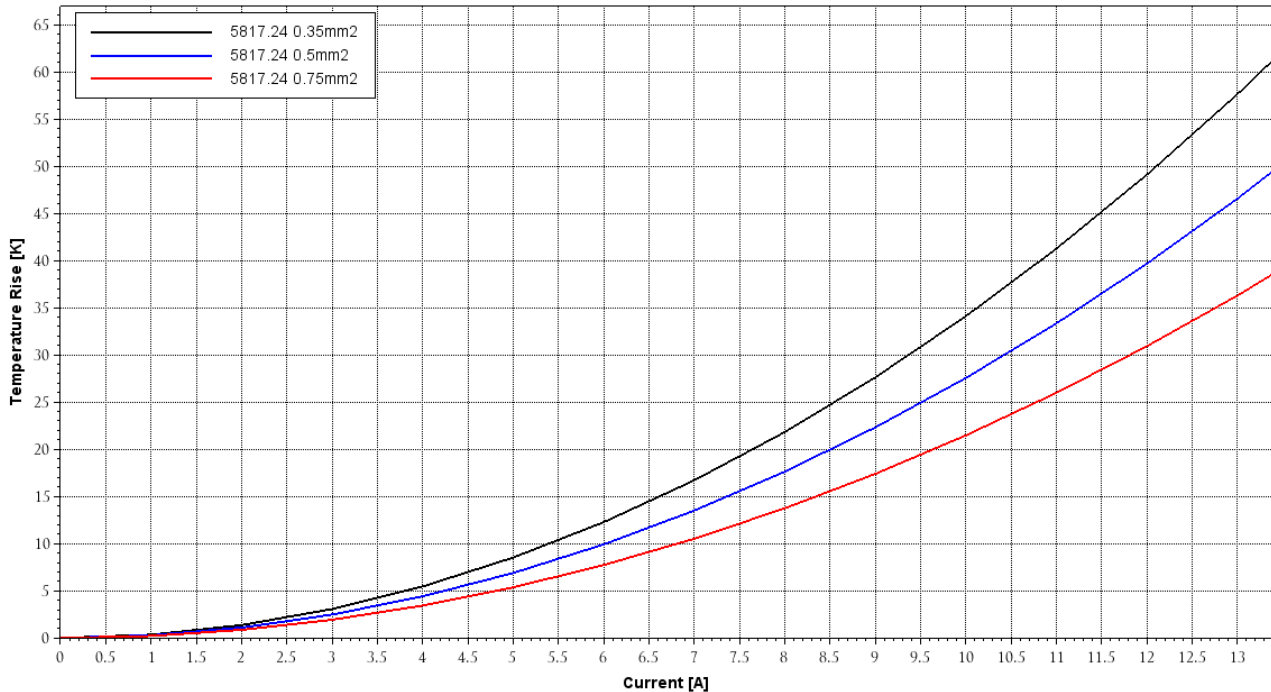

Curves show terminal behavior in a first connection, working in open air (without connector). Security margin has been applied.

Disclaimer

Data obtained from Escubedo Laboratory essays, using own methodology, cabling, equipment and original crimping tools, done in laboratory conditions and following the indicated standards, errors and omissions excepted. This document has no contractual meaning and it is publicised only for informative purposes. It can be changed without prior notice. The end customer has the sole responsibility to check these characteristics in its environment and with its own components, manufacturing methods and equipment. See also the full range product overview if available. For further information please visit our web site or contact us.

Rev. Nr.	Modification	Date	Created/Revised	Approved
1	Creation/Update	12/06/2014	D.Martinez / E.Roura	JC Sanchez
2	Update crimp width	29/07/2014	D.Martinez / E.Roura	JC Sanchez
3	Update	27/08/2014	D.Martinez / E.Roura	JC Sanchez
4	Update	08/01/2016	D.Martinez / E.Roura	JC Sanchez