

4932.** 6.3 (.250) TYPE SERIES · RECEPTACLES



Specification Basic self locking under TP design

For male (mm) 6,3x0,8

Wire size mm² (AWG) 1-2,5 (18-14)

Ø Insulation (mm) 3-4,3

Materials, temperature and contact resistance

Part nr.	Material	Finishing	Max. Temp. (°C)	Contact Resist (mΩ)
4932.00	Brass	Natural	110	0.75
4932.01	Brass	Pre-tin-plated	120	0.50
4932.02	Brass	Tin plated	120	0.55
4932.24	Steel	Nickel-plated	300	2.00
4932.30	Bronze	Natural	120	(T.B.D.)
4932.31	Bronze	Pre-tin-plated	130	0.60
4932.32	Bronze	Tin plated	130	(T.B.D.)
4932.70	German Silver	Natural	210	2.25

Material thickness (mm) 0,4

Max. rated current

Wire section	4932.00 / 01 / 02 / 24 / 30 / 31 / 32 / 70
1.00 mm ²	12A
1.50 mm ²	16A
2.50 mm ²	20A

Insertion / Withdrawal forces

	4932.00 / 01 / 02 / 30 / 31 / 32	4932.24 / 70
1st Insertion (max)	35N ¹	35N ¹
1st Withdrawal (min, locking enabled)	90N ¹	70N ¹

¹ Valid for Natural Brass Tab

Application tool MN4122

Wire strip length 5.5 (±0.5) mm

Crimping parameters & pull out force

Wire section (±10%)	Conductor		Insulator Width (mm)	Pull-out force (N)
	Height (mm)	Width (mm)		
1.00 mm ²	1.55 (±0.05)	3.05 (±0.05)	4.09 (±0.10)	108N @ 60s
1.50 mm ²	1.70 (±0.05)	3.06 (±0.05)	4.10 (±0.10)	150N @ 60s
2.00 mm ²	1.80 (±0.05)	3.07 (±0.05)	4.11 (±0.10)	150N @ 60s
2.50 mm ²	1.90 (±0.05)	3.08 (±0.05)	4.12 (±0.10)	230N @ 60s

Values only valid for the application tool specified upwards. The insulator widths are only indicative as they are dependent on the sheath thickness of the wire used.

Winding number 7000

Approved regulations

Part nr.	Approval	Standard	File	Certified framework
4932.00	UL	UL 310	E211727	AWG 18-14 (16-41 Stranded Cu) / MN4932
4932.01	UL	UL 310	E211727	AWG 18-14 (16-41 Stranded Cu) / MN4932
4932.24	UL	UL 310	E211727	AWG 18-14 (16-41 Stranded Cu) / MN4932

4932.**
6.3 (.250) TYPE SERIES · RECEPTACLES



Approvals



Drawing

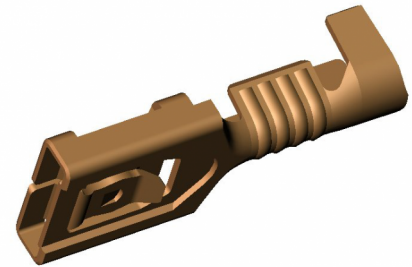
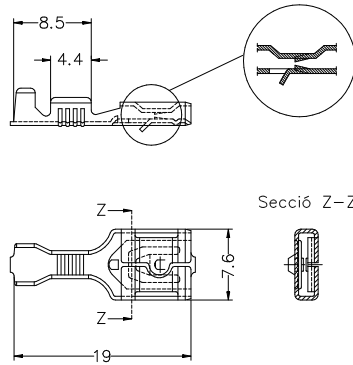

4932.01 PRE-TIN-PLATED BRASS
6.3 (.250) TYPE SERIES · RECEPTACLES



Derating curve Current carrying capacity vs. Ambient temperature

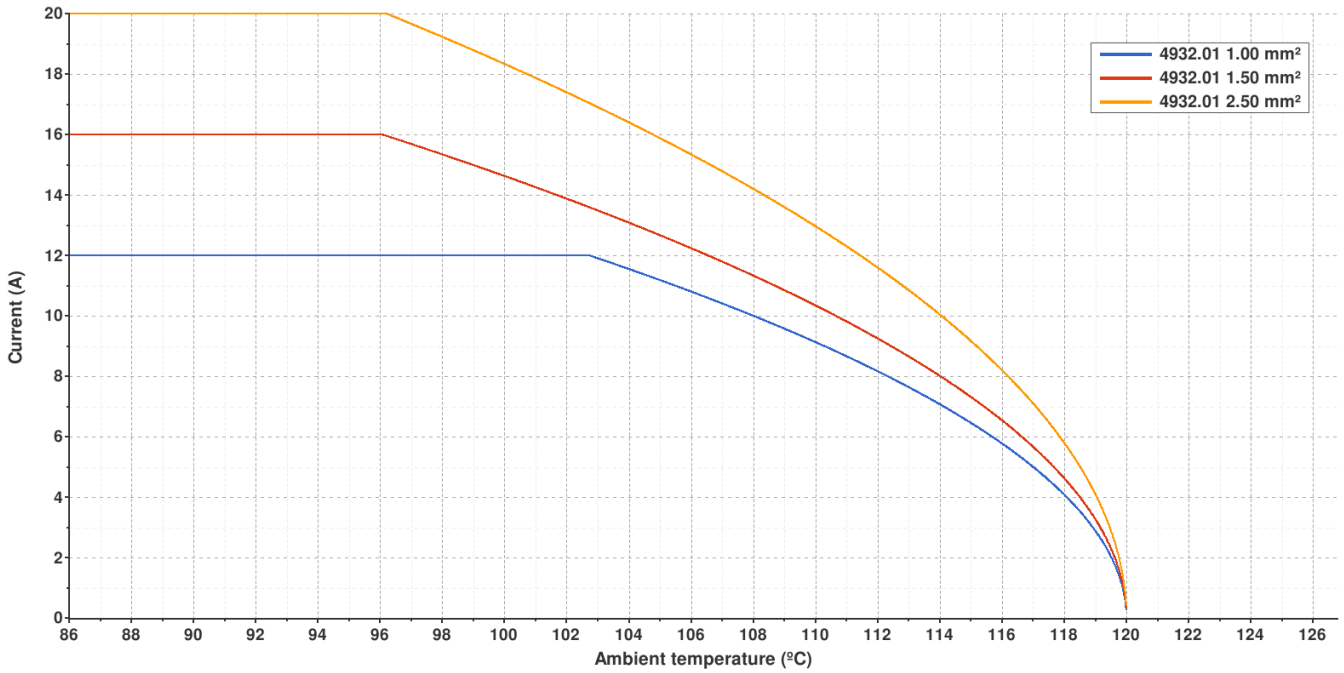

Temperature rise curve Terminal temperature rise due to the current carried

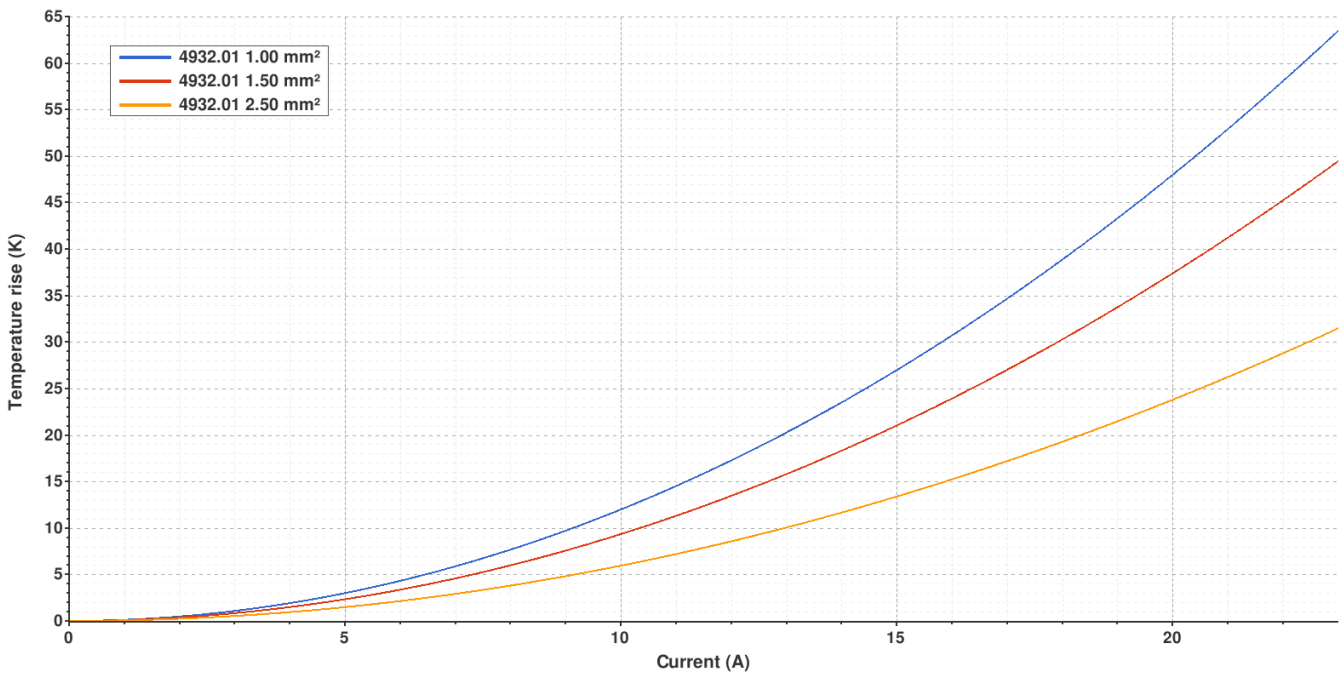

Valid for Natural Brass Tab

4932.24 NICKEL-PLATED STEEL
6.3 (.250) TYPE SERIES · RECEPTACLES



Derating curve Current carrying capacity vs. Ambient temperature

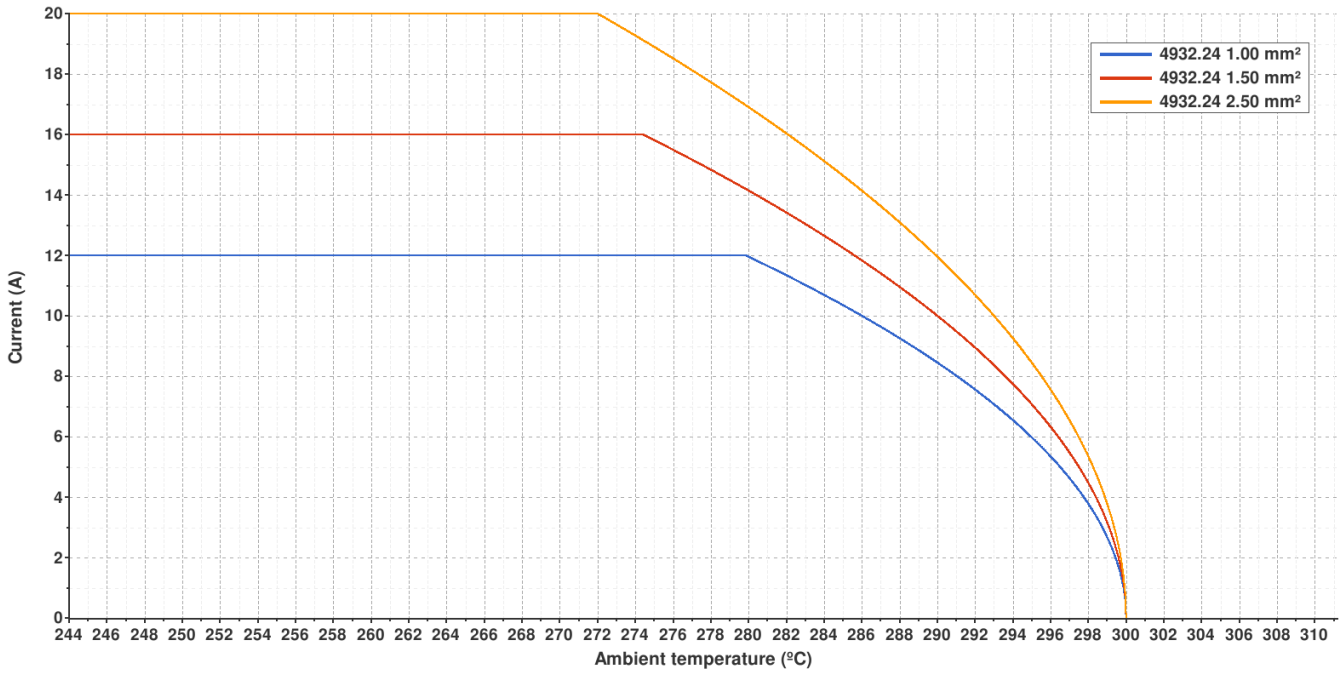

Temperature rise curve Terminal temperature rise due to the current carried

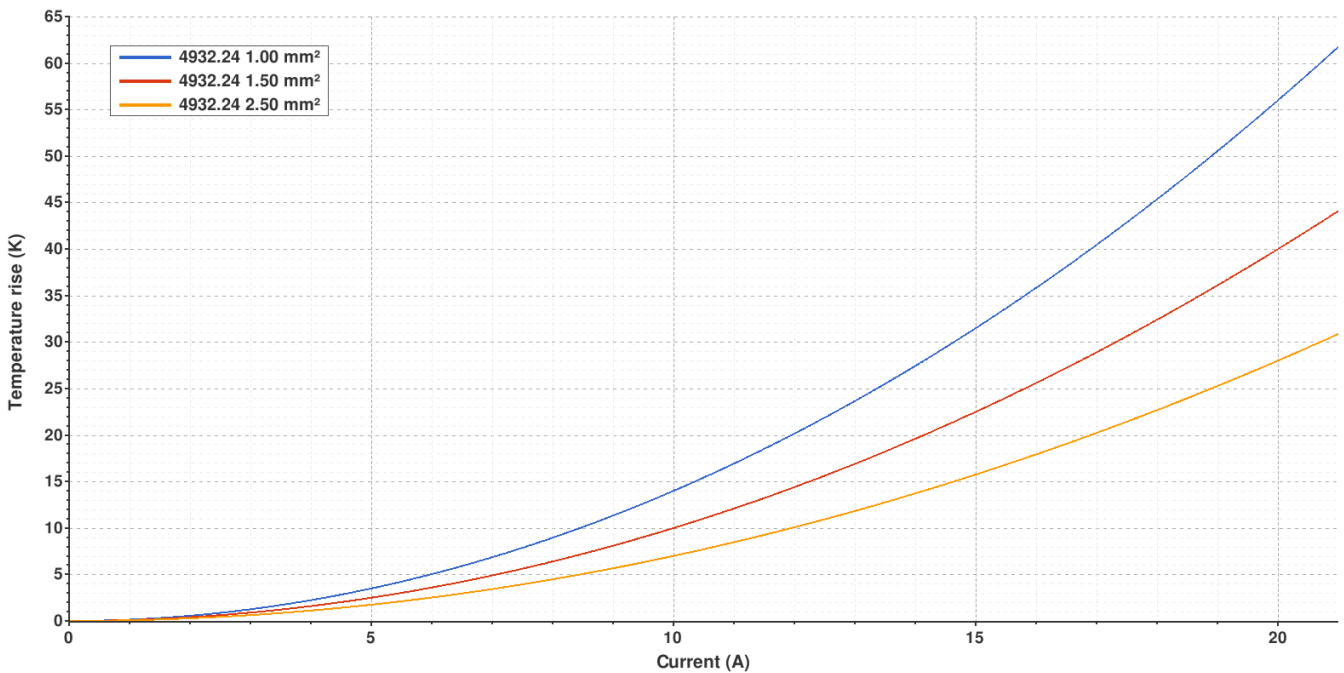

Valid for Natural Brass Tab

4932.31 PRE-TIN-PLATED BRONZE
6.3 (.250) TYPE SERIES · RECEPTACLES



Derating curve Current carrying capacity vs. Ambient temperature

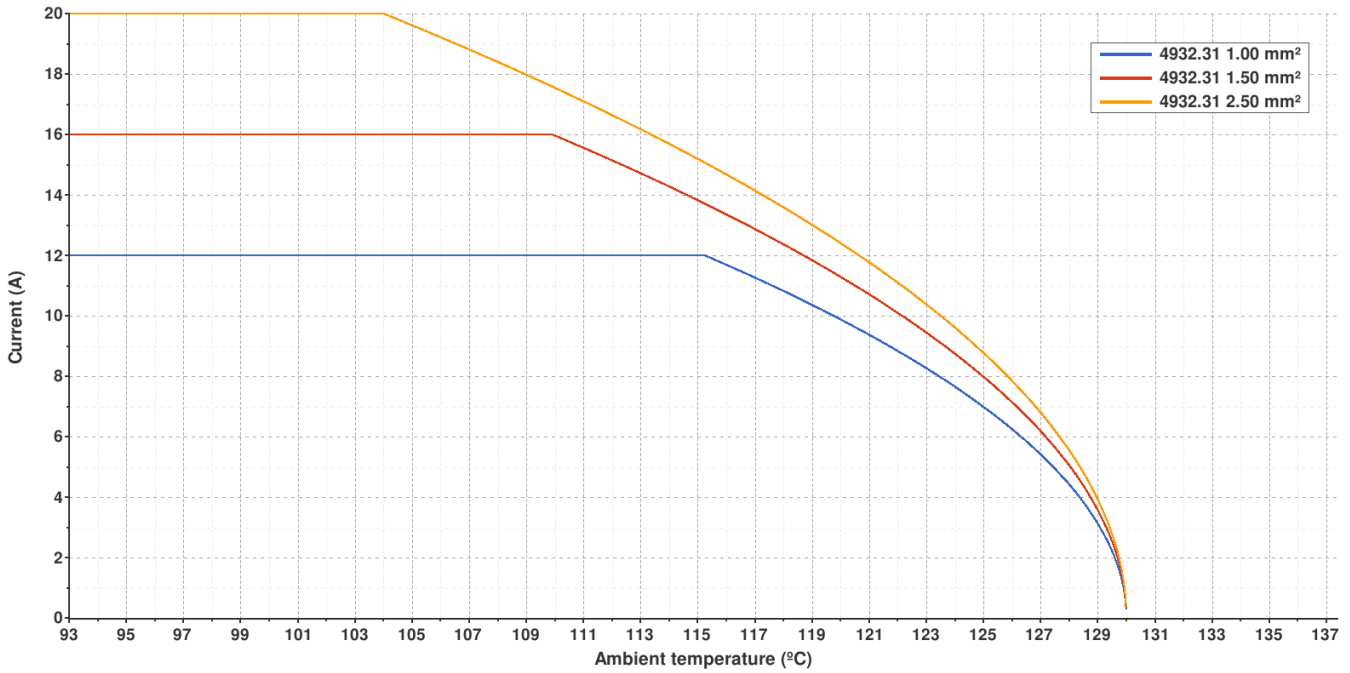

Temperature rise curve Terminal temperature rise due to the current carried

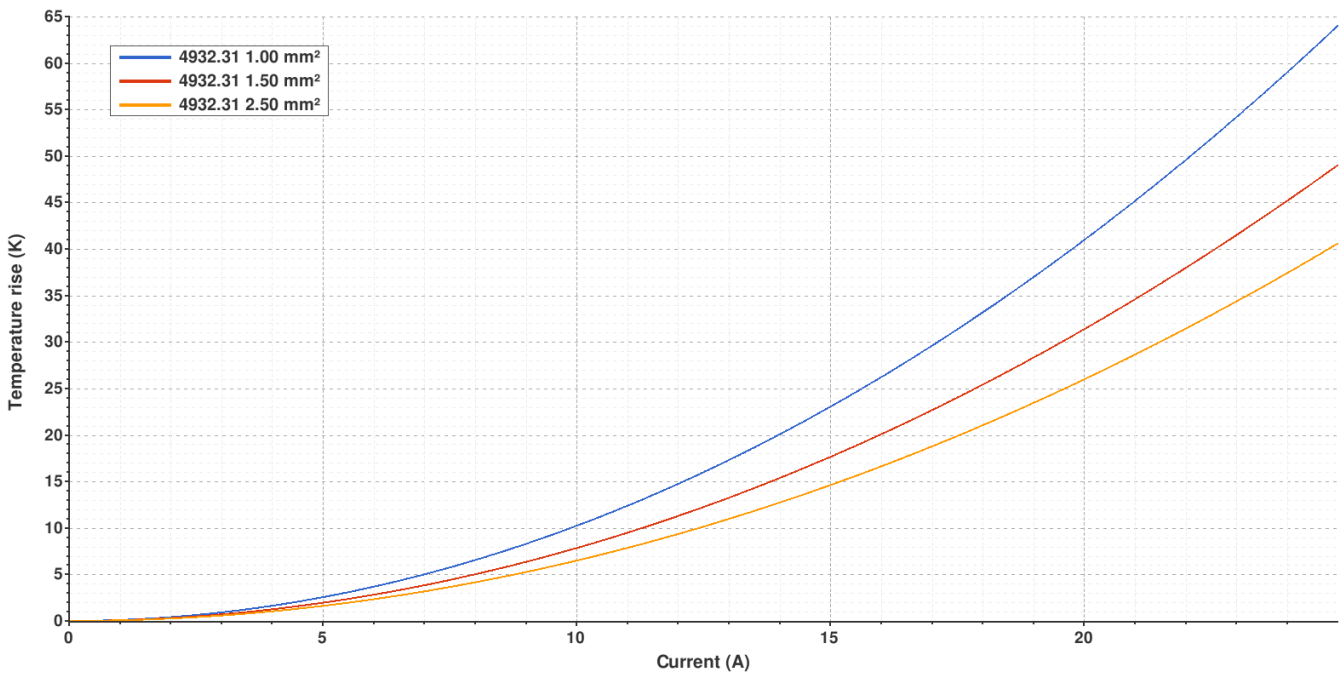

Valid for Natural Brass Tab

4932.70 NATURAL GERMAN SILVER
6.3 (.250) TYPE SERIES · RECEPTACLES



Derating curve Current carrying capacity vs. Ambient temperature

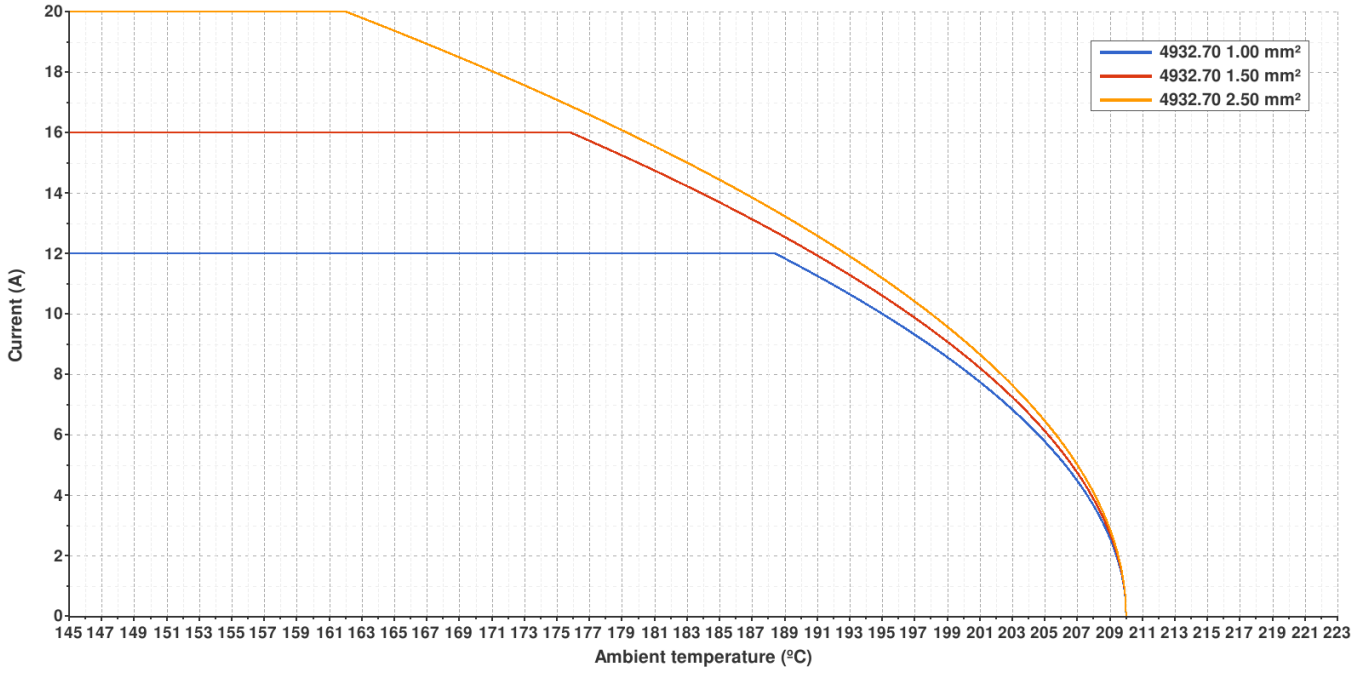

Temperature rise curve Terminal temperature rise due to the current carried

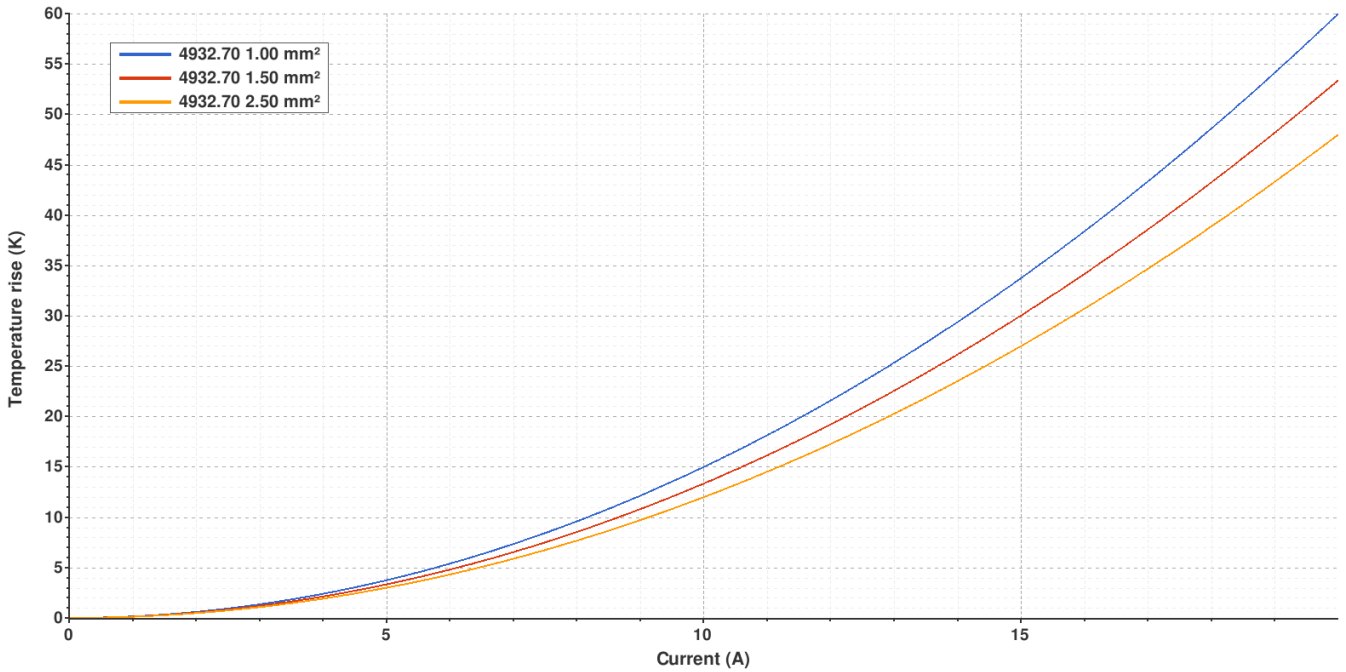

Valid for Natural Brass Tab

4932.**

6.3 (.250) TYPE SERIES · RECEPTACLES



(T.B.D.): To be determined

Disclaimer

Data obtained from Escubedo Laboratory essays, using own methodology, cablings, equipment and original crimping tools, done in laboratory conditions and following the indicated standards, errors and omissions excepted. This document has no contractual meaning and it is publicised only for informative purposes. It can be changed without prior notice. The end customer has the sole responsibility to check these characteristics in its environment and with its own components, manufacturing methods and equipment. See also the full range product overview if available. For further information please visit our web site or contact us

Rev. Nr.	Concept	Date	Created/Revised	Approved
A2	Change company name and logo	2021-10-21	Laboratory Dept.	E. Roura
A1	Datasheet generated automatically [A1]	2019-02-19	Laboratory Dept.	E. Roura

Escubedo Connection Systems, S.A.U. · Ctra. de Girona-Olot Km. 35,5 · 17843 Riudellots de la Creu · Girona · Spain
 Tel.: 34 972 171 706 · Fax: +34 972 171 714 · info@escubedo.com · www.escubedo.com