

3391.** RING TERMINALS · WITH INSULATION SUPPORT



Specification	Flags
Ø (mm)	3,6
Wire size mm² (AWG)	0,5-1,5 (20-16)
Ø Insulation (mm)	2-3,3

Materials, temperature and contact resistance

Part nr.	Material	Finishing	Max. Temp. (°C)
3391.00	Brass	Natural	110
3391.02	Brass	Tin plated	120
3391.30	Bronze	Natural	120
3391.32	Bronze	Tin plated	130

Material thickness (mm) 0,4

Application tool MN3388

Wire strip length 5.0 (±0.5) mm

Crimping parameters & pull out force

Wire section (±10%)	Conductor		Insulator	Pull-out force (N)
	Height (mm)	Width (mm)	Width (mm)	
0.50 mm ²	1.75 (±0.03)	2.84 (±0.03)	3.47 (±0.10)	56N @ 60s
0.75 mm ²	1.80 (±0.05)	2.84 (±0.05)	3.47 (±0.10)	84N @ 60s
1.00 mm ²	1.85 (±0.05)	2.92 (±0.05)	3.49 (±0.10)	108N @ 60s
1.50 mm ²	1.90 (±0.05)	2.98 (±0.05)	3.65 (±0.10)	150N @ 60s

Values only valid for the application tool specified upwards. The insulator widths are only indicative as they are dependent on the sheath thickness of the wire used.

Winding number 5000

Approvals



Drawing

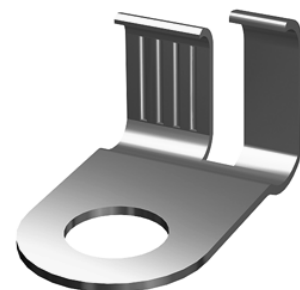
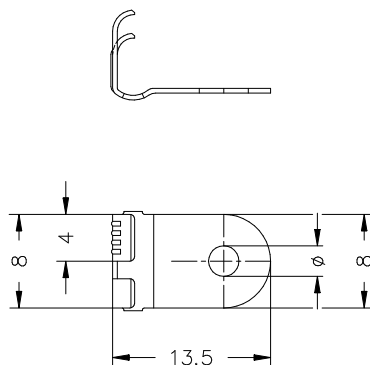

3391.**
RING TERMINALS · WITH INSULATION SUPPORT**Disclaimer**

Data obtained from Escubedo Laboratory essays, using own methodology, cablings, equipment and original crimping tools, done in laboratory conditions and following the indicated standards, errors and omissions excepted. This document has no contractual meaning and it is publicised only for informative purposes. It can be changed without prior notice. The end customer has the sole responsibility to check these characteristics in its environment and with its own components, manufacturing methods and equipment. See also the full range product overview if available. For further information please visit our web site or contact us

Rev. Nr.	Concept	Date	Created/Revised	Approved
A2	Change company name and logo	2021-10-21	Laboratory Dept.	E. Roura
A1	Datasheet generated automatically [A1]	2018-10-01	Laboratory Dept.	E. Roura

Escubedo Connection Systems, S.A.U. · Ctra. de Girona-Olot Km. 35,5 · 17843 Riudellots de la Creu · Girona · Spain
Tel.: 34 972 171 706 · Fax: +34 972 171 714 · info@escubedo.com · www.escubedo.com