

## 242FP23\*\* UP-FIT SERIES · 4.20 MM UP-FIT CONNECTIONS



**Specification** UP-FIT Male-Holder Panel Connectors

**Ways** 6

**Thermal Characteristics**

Part nr.	Raw material	Color	Flammability Class (UL 94)	Glow Wire Test (GWT) (IEC60695-2-11)	Glow Wire Flammability Index (IEC60695-2-12)	RTI electrical (Max. Operating Temp.)
242FP2310	PA66V2	Natural	V2	(T.B.D.)	850°C	105°C
242FP2330	PA66V0	Natural	V0	(T.B.D.)	960°C	140°C
242FP2340	NO FLAME	Natural	V2	(T.B.D.)	960°C	130°C

For other materials and colors ask to: [info@escubedo.com](mailto:info@escubedo.com)

**Max. rated voltage** 600V

**Compatible terminals** 7545\*\*, 7546\*\*, 7547\*\*

**Insertion / Withdrawal forces**

	242FP2310 / 30 / 40
Terminal into connector cavity. Insertion force (max)	12N
Terminal from connector cavity - only primary lock. Withdrawal force (min)	60N

**Counterpart** 242M23\*\*

**Approved regulations**

Part nr.	Approval	Standard	File	Certified framework
242FP2310 <sup>1</sup>	UL	UL 1977	E223221	V2 / RTI Elec., Max. Operating Temp, 130°C
242FP2330 <sup>1</sup>	UL	UL 1977	E223221	V0 / RTI Elec., Max. Operating Temp, 140°C
242FP2340 <sup>1</sup>	UL	UL 1977	E223221	V2 / RTI Elec., Max. Operating Temp, 130°C

<sup>1</sup> Cat. No. meets with the standard UL1977 as a component of UP-FIT full connection system.

Rated current and voltage:

- 6 poles - AWG 28 - 2A/600V (USR, CND)
- 6 poles - AWG 26 - 2A/600V (USR, CND)
- 6 poles - AWG 24 - 3A/600V (USR, CND)
- 6 poles - AWG 22 - 3A/600V (USR, CND)
- 6 poles - AWG 20 - 4A/600V (USR, CND)
- 6 poles - AWG 18 - 5A/600V (USR, CND)
- 6 poles - AWG 16 - 6A/600V (USR, CND)

**Approvals**



**Drawing**

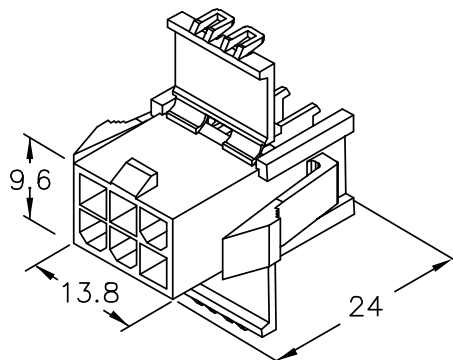

## 242FP23\*\*

### UP-FIT SERIES · 4.20 MM UP-FIT CONNECTIONS



(T.B.D.): To be determined

**Disclaimer**

Data obtained from Escubedo Laboratory essays, using own methodology, cablings, equipment and original crimping tools, done in laboratory conditions and following the indicated standards, errors and omissions excepted. This document has no contractual meaning and it is publicised only for informative purposes. It can be changed without prior notice. The end customer has the sole responsibility to check these characteristics in its environment and with its own components, manufacturing methods and equipment. See also the full range product overview if available. For further information please visit our web site or contact us

Rev. Nr.	Concept	Date	Created/Revised	Approved
A4	Update insertion / withdrawal forces	2024-03-21	E. Roura (Laboratory Dept.)	O. Roura (Engineering Dept.)
A3	Change company name and logo	2021-10-21	Laboratory Dept.	E. Roura
A2	Update UL Regulation	2018-08-10	Laboratory Dept.	E. Roura
A1	Datasheet generated automatically [A1]	2018-08-03	Laboratory Dept.	E. Roura

Escubedo Connection Systems, S.A.U. · Ctra. de Girona-Olot Km. 35,5 · 17843 Riudellots de la Creu · Girona · Spain  
 Tel.: 34 972 171 706 · Fax: +34 972 171 714 · [info@escubedo.com](mailto:info@escubedo.com) · [www.escubedo.com](http://www.escubedo.com)