

242F24** UP-FIT SERIES · 4.20 MM UP-FIT CONNECTIONS



Specification UP-FIT Male-Holder Connectors

Ways 8

Thermal Characteristics

Part nr.	Raw material	Color	Flammability Class (UL 94)	Glow Wire Test (GWT) (IEC60695-2-11)	Glow Wire Flammability Index (IEC60695-2-12)	RTI electrical (Max. Operating Temp.)
242F2410	PA66V2	Natural	V2	(T.B.D.)	850°C	105°C
242F2430	PA66V0	Natural	V0	(T.B.D.)	960°C	140°C
242F2440	NO FLAME	Natural	V2	(T.B.D.)	960°C	130°C

For other materials and colors ask to: info@escubedo.com

Max. rated voltage 600V

Compatible terminals 7545**, 7546**, 7547**

Insertion / Withdrawal forces

	242F2410 / 30 / 40
1st Insertion (max)	12N
1st Withdrawal (min, secondary lock only)	60N

Counterpart 242M24**

Approved regulations

Part nr.	Approval	Standard	File	Certified framework
242F2410 ¹	UL	UL 1977	E223221	V2 / RTI Elec., Max. Operating Temp, 130°C
242F2430 ¹	UL	UL 1977	E223221	V0 / RTI Elec., Max. Operating Temp, 140°C
242F2440 ¹	UL	UL 1977	E223221	V2 / RTI Elec., Max. Operating Temp, 130°C

¹ Cat. No. meets with the standard UL1977 as a component of UP-FIT full connection system.

Rated current and voltage:
 8 poles - AWG 28 - 1A/600V (USR, CND)
 8 poles - AWG 26 - 1A/600V (USR, CND)
 8 poles - AWG 24 - 2A/600V (USR, CND)
 8 poles - AWG 22 - 3A/600V (USR, CND)
 8 poles - AWG 20 - 4A/600V (USR, CND)
 8 poles - AWG 18 - 5A/600V (USR, CND)
 8 poles - AWG 16 - 6A/600V (USR, CND)

Approvals



Drawing

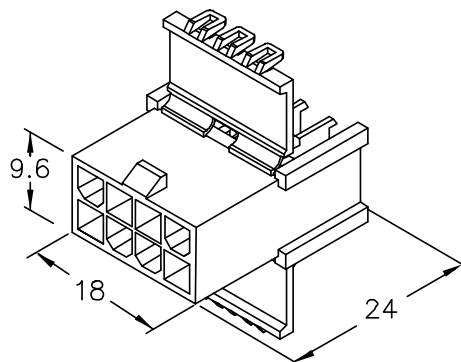

242F24****UP-FIT SERIES · 4.20 MM UP-FIT CONNECTIONS**

(T.B.D.): To be determined

Disclaimer

Data obtained from Escubedo Laboratory essays, using own methodology, cablings, equipment and original crimping tools, done in laboratory conditions and following the indicated standards, errors and omissions excepted. This document has no contractual meaning and it is publicised only for informative purposes. It can be changed without prior notice. The end customer has the sole responsibility to check these characteristics in its environment and with its own components, manufacturing methods and equipment. See also the full range product overview if available. For further information please visit our web site or contact us

Rev. Nr.	Concept	Date	Created/Revised	Approved
A3	Change company name and logo	2021-10-21	Laboratory Dept.	E. Roura
A2	Update UL Regulation	2018-08-10	Laboratory Dept.	E. Roura
A1	Datasheet generated automatically [A1]	2018-08-03	Laboratory Dept.	E. Roura

Escubedo Connection Systems, S.A.U. · Ctra. de Girona-Olot Km. 35,5 · 17843 Riudellots de la Creu · Girona · Spain
Tel.: 34 972 171 706 · Fax: +34 972 171 714 · info@escubedo.com · www.escubedo.com