



**19927.\*\***  
**PLANE TABS · MALES**



**Specification** 4.8 mm Males

**Typology** 0° 4.8 mm male

**Ø (mm)** 4,2

**Din** 46342

**Materials, temperature and contact resistance**

Part nr.	Material	Finishing	Max. Temp. (°C)
19927.00	Brass	Natural	110
19927.02	Brass	Tin plated	120

**Material thickness (mm)** 0,5

**Approvals**



**Drawing**

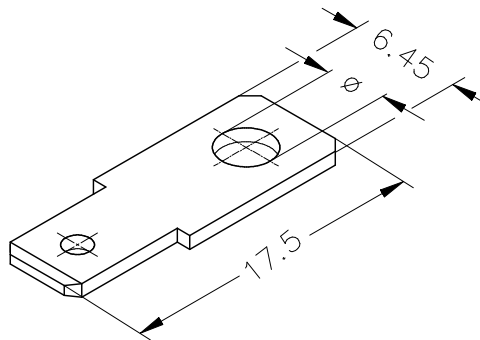

**Disclaimer**

Data obtained from Escubedo Laboratory essays, using own methodology, cabling, equipment and original crimping tools, done in laboratory conditions and following the indicated standards, errors and omissions excepted. This document has no contractual meaning and it is publicised only for informative purposes. It can be changed without prior notice. The end customer has the sole responsibility to check these characteristics in its environment and with its own components, manufacturing methods and equipment. See also the full range product overview if available. For further information please visit our web site or contact us

Rev. Nr.	Concept	Date	Created/Revised	Approved
A1	Datasheet generated automatically	2018-09-19	Laboratory Dept.	E. Roura